

# Dell Networking S5000 Getting Started Guide



# Notes, Cautions, and Warnings

 **NOTE:** A NOTE indicates important information that helps you make better use of your computer.

 **CAUTION:** A CAUTION indicates either potential damage to hardware or loss of data and tells you how to avoid the problem.

 **WARNING:** A WARNING indicates a potential for property damage, personal injury, or death.

**Copyright © 2014 Dell Inc. All rights reserved.** This product is protected by U.S. and international copyright and intellectual property laws. Dell™ and the Dell logo are trademarks of Dell Inc. in the United States and/or other jurisdictions. All other marks and names mentioned herein may be trademarks of their respective companies.

2014 - 12

Rev. A01

# Getting Started Guide

This document is intended as a Getting Started Guide to get new systems up and running and ready for configuration. For complete installation and configuration information, refer to the documents listed below:

**Table 1. S5000 Documents**

| <b>Information</b>                              | <b>Documentation</b>  |
|---|---|
| Hardware installation and power-up instructions | <i>Installing the S5000 Switch</i>                            |
| Software configuration                          | <i>FTOS Configuration Guide for the S5000 Switch</i>          |
| Command line interface                          | <i>FTOS Command Line Reference Guide for the S5000 Switch</i> |
| Latest updates                                  | <i>FTOS Release Notes for the S5000 Switch</i>                |

# Introduction

This document provides basic information about the S5000 switch, including how to install the switch and perform the initial configuration.

For information about how to configure and monitor switch features, refer to the *FTOS Configuration Guide for the S5000 Switch*, which is available on the Dell Support website at <http://www.dell.com/support/manuals>.

## Product Description

The S5000 is part of Dell Networking's S-Series switches for Data Center Top of Rack (ToR) switches.

The S5000 is purpose-built to provide architectural flexibility for unified and virtualized environments. It is a 10G ToR solution that enables converged local area networks (LAN) and storage area networks (SAN) in the same box. The S5000 delivers Fibre Channel over Ethernet (FCoE) and Fibre Channel (FC) capability in a one rack unit (RU) ToR switch form factor.

The S5000 supports Data Center Bridging (ETS/PFC/DCBX), FCoE Transit (FIP Snooping), NPIV Proxy Gateway (NPG), FC Fabric services (zoning, name server, login server, FSPF, and so on), and Internet small computer system interface (iSCSI) storage traffic. The S5000 also provides aggregation and convergence functionality using pluggable modules for flexible configuration.

## Unpacking the Switch

The S5000 and its accessories are shipped in multiple boxes. Before unpacking the switch, inspect the container and immediately report any evidence of damage. Verify that you have received your ordered items. For example, if you order one S5000 switch, the following items are included.

 **WARNING: If any item is missing or damaged, contact your Dell Networking representative or reseller for instructions.**

 **WARNING: Electrostatic discharge (ESD) damage can occur if components are mishandled. Always wear an ESD-preventive wrist or heel ground strap when handling the S5000 and its components.**

- One S5000 switch
- Two Fans
- Two Power Supplies (either AC or DC)
- One rail kit (#1 and #2 Phillips screwdrivers required)
- Screws for rack installation
- Two to Four I/O Modules (according to order)

- Two Blanks
  - One RJ-45 to DB-9 female cable
  - Two AC or DC power cords for AC or DC units (country/region specific)
  - *Getting Started Guide*
  - *Safety and Regulatory Information*
  - *Warranty and Support Information*
  - *Software License Agreement*
1. Place the container on a clean, flat surface and cut all straps securing the container.
  2. Open the container or remove the container top.
  3. Carefully remove all components from the container and place it on a secure and clean surface.
  4. Remove all packing material.
  5. Inspect the switch and accessories for damage.

## Important Points Before You Continue

- Identify the I/O and Utility panel on the chassis. The I/O panel has four fixed 40GbE ports on the right side of the panel, refer to Figure 1. The Utility panel has the power supply slots, LEDs, and USB slots on the left side of the panel, refer to Figure 3.
- Identify slots 0, 1, 2, and 3 on the I/O panel, refer to Figure 2. You can insert a Unified Port module only in slot 0. You can install the Ethernet modules in slots 0, 1, 2, and 3.
- Identify slots 0, 1, 2, and 3 on the Utility panel, refer to Figure 3. You can insert Power supply units (PSUs) only in slots 0 and 3. You can insert the Fan modules in any of the slots.

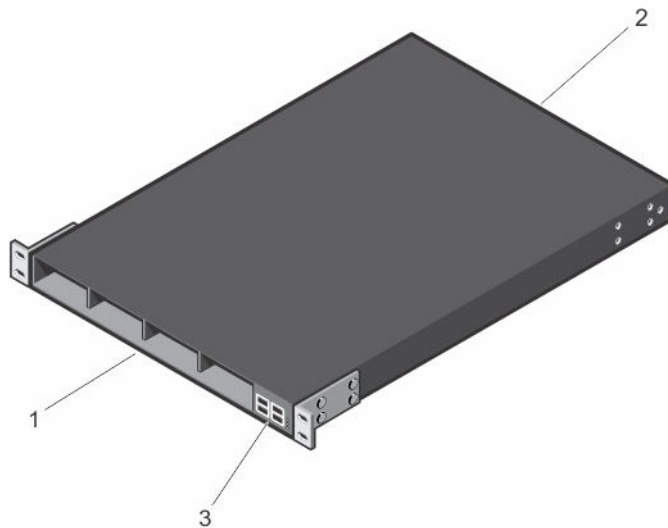

**Figure 1. S5000 I/O and Utility Panels**

- |  |  |
|--|--|
| <ol style="list-style-type: none"> <li>1. I/O panel</li> <li>3. Four 40GbE QSFP+ ports (each port ALSO supports 4 x 10GbE mode)</li> </ol> | <ol style="list-style-type: none"> <li>2. Utility panel</li> </ol> |
|--|--|

## Hardware Installation Overview

To install the S5000, follow these steps:

1. Attach the mounting brackets.
2. Install the S5000 chassis into a 4-post rack or cabinet.
3. Ground the rack.
4. Install the Ethernet and/or Unified Port modules (Unified Port module must be installed only in slot 0).
5. Install the power supplies.
6. Secure the power cables.
7. Install the fan modules.
8. Install the SFP+ and QSFP+ optics.
9. Supply power and power up the system.

## Hardware Overview

This section contains information about device characteristics and modular hardware configurations for the S5000.

The S5000 has the following physical dimensions:

- Height: 1.71 inches (43.5 mm)
- Width: 17.4 inches (441.9 mm)
- Depth: 28 inches (711.2 mm)

The S5000 has a chassis design with 640Gbps switching bandwidth.

The system also provides one DB9 RS-232 console port with YOST RJ-45 pinout and a dedicated Ethernet service port for out-of-band (OOB) management functions.

### I/O Panel

All fixed data ports (4 × 40GbE quad small form-factor pluggable plus [QSFP+] ports) and the four slots for pluggable modules are on the I/O panel.

The I/O panel includes:

- Pluggable Modules
  - 12-Port Ethernet Module (100MbE/1GbE/10GbE speeds, RJ-45 connector)
  - 12-Port Ethernet Module (1GbE/10GbE speeds, SFP+ connector)
  - 12-Port Unified Port Module (10GbE or 2Gb/4Gb/8Gb speeds for Fibre Channel, SFP+ connector)
- 4 × 40GbE QSFP+ Ports and light emitting diodes (LEDs)

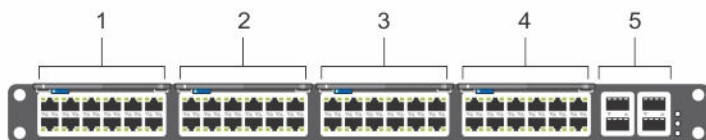

**Figure 2. S5000 I/O Panel**

- |  |  |
|--|--|
| 1. Slot 0 (supports Ethernet and Unified Port modules) | 2. Slot 1 (supports only Ethernet modules) |
| 3. Slot 2 (supports only Ethernet modules)             | 4. Slot 3 (supports only Ethernet modules) |

- Four 40GbE QSFP+ ports (each port ALSO supports 4 × 10GbE mode)

**NOTE:** The LED displays for the system status are on both sides of the chassis. The fan and power status LEDs are on the Utility panel.

## Utility Panel

The Utility panel side of the platform contains the fan and power modules.

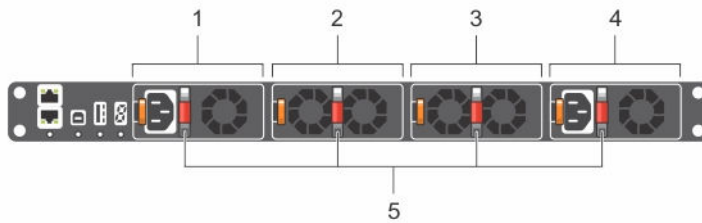

**Figure 3. S5000 Power Supplies and Fan Modules**

- Slot 0 (for PSU 0)
- Slot 1 (for Fan Module 0)
- Slot 2 (for Fan Module 1)
- Slot 3 (for PSU 1)
- Grab Handles

## Power Supplies

The S5000 supports two hot-swappable PSUs.

**NOTE:** The PSUs must be installed at the customer site.

The S5000 has SKUs that support the following configurations:

- AC PSU with fan airflow from I/O to Utility
- AC-R PSU with fan airflow from Utility to I/O
- DC PSU with fan airflow from I/O to Utility
- DC-R PSU with fan airflow from Utility to I/O

PSUs are field replaceable. To ensure power redundancy and adequate cooling, install two power supplies in the switch. When running with full redundancy (two PSUs installed and running), you can remove and replace one PSU while the other PSU is running without disrupting traffic.

## Fans

The S5000 supports two fan trays with airflow directions from I/O to Utility or Utility to I/O.

Do not mix I/O to Utility and Utility to I/O airflows in a single S5000 chassis. All fans and PSUs in a configuration must be in the same airflow direction. If you create a mixed airflow configuration, the software notifies you of the invalid configuration.

The fans must be installed at the customer site.

## Port Numbering Convention

Even-numbered ports are at the bottom of the I/O panel and for modules odd-numbered ports are at the top of the I/O panel.

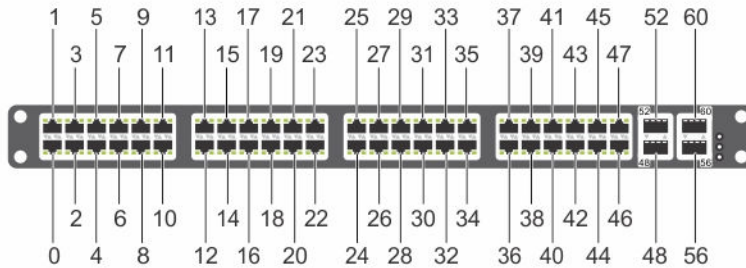

**Figure 4. Port Numbering**

The previous figure shows the fixed four 40GbE data ports (ports 48, 52, 56, and 60) and the four slots for pluggable modules on the S5000 I/O panel. You can also use the 40GbE ports in 4 × 10GbE mode.

The S5000 supports the following possible modules:

- 12-Port Ethernet Module (100MbE/1GbE/10GbE speeds, RJ-45 connector) (slot 0, 1, 2, or 3)
- 12-Port Ethernet Module (1GbE/10GbE speeds, SFP+ connector) (slot 0, 1, 2, or 3)
- 12-Port Unified Port Module (10GbE or 2Gb/4Gb/8Gb speeds for Fibre Channel, SFP+ connector) (slot 0)

The valid slot numbers are stack-unit numbers (from 0 to 11). The valid port numbers for each interface type are:

- 100MbE: Ports 0 to 47
- 1GbE: Ports 0 to 47
- 10GbE: Ports 0 to 63
- 40GbE: Ports 48, 52, 56, and 60
- Fibre Channel: Ports 0 to 11
- Management: Port 0

## System Status

You can view S5000 status information in several ways, including LEDs and through the CLI `show` commands and with simple network management protocol (SNMP).

For more information about these options, refer to the *Dell Networking OS Command Line Reference Guide* and *Dell Networking OS Configuration Guide for the S5000 Switch*.

As shown in the following figure, the S5000 includes LED displays on the I/O and Utility side of the chassis. When the S5000 powers up or reloads, the status LED on the power supplies are solid green.

The following table lists the LED definitions for the S5000 system.

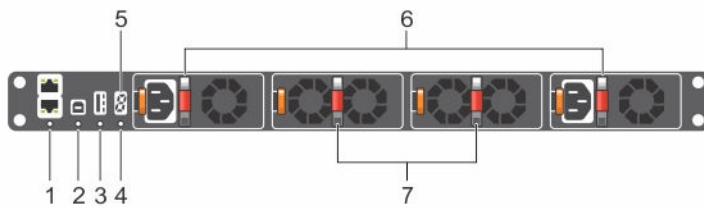
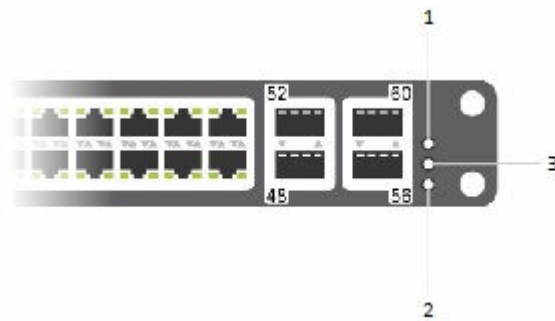

**Figure 5. System LEDs (Utility Panel) (AC Power Supplies installed)**

1. Locator beacon LED
2. Alarm LED
3. System status LED
4. Master LED
5. Seven-segment display to identify Stack ID
6. PSU status LED
7. Fan status LED

**NOTE:** For AC PSUs, an illuminated translucent handle indicates the power status.



**NOTE:** For DC PSUs, the power status LED is on the upper-left corner.



**Figure 6. System LEDs (I/O Panel)**

1. Locator beacon LED
2. Alarm LED
3. System status LED

**Table 2. System LED Displays (Utility and I/O Panel)**

| Label  | LED Color/Display  | Description   |
|--|--|---|
| Locator beacon LED  | <ul style="list-style-type: none"> <li>• Off</li> <li>• Blue</li> </ul>                                  | <ul style="list-style-type: none"> <li>• No activity</li> <li>• System beacon/locator</li> </ul>                      |
| Alarm LED           | <ul style="list-style-type: none"> <li>• Off</li> <li>• Amber solid</li> <li>• Red solid</li> </ul>      | <ul style="list-style-type: none"> <li>• No alarm</li> <li>• Minor alarm</li> <li>• Critical alarm</li> </ul>         |
| System status LED   | <ul style="list-style-type: none"> <li>• Off</li> <li>• Green solid</li> <li>• Green blinking</li> </ul> | <ul style="list-style-type: none"> <li>• No power</li> <li>• Normal operation</li> <li>• System is booting</li> </ul> |

| Label  | LED Color/Display   | Description  |
|--|---|--|
| Master LED  | <ul style="list-style-type: none"> <li>Amber solid</li> <li>Green solid</li> <li>Green blinking</li> <li>Off</li> </ul> | <ul style="list-style-type: none"> <li>System in card problem state</li> <li>Switch in Stacking Master mode OR Switch in Standalone mode</li> <li>Switch in Stacking Standby mode</li> <li>Switch in Stacking Member mode</li> </ul> |
| PSU status LED   | <ul style="list-style-type: none"> <li>Green solid</li> <li>Off</li> </ul>  | <ul style="list-style-type: none"> <li>Normal operation</li> <li>Power not present</li> </ul>  |
| Fan status LED   | <ul style="list-style-type: none"> <li>Green solid</li> <li>Off</li> </ul>  | <ul style="list-style-type: none"> <li>Normal operation</li> <li>Power not present</li> </ul>  |

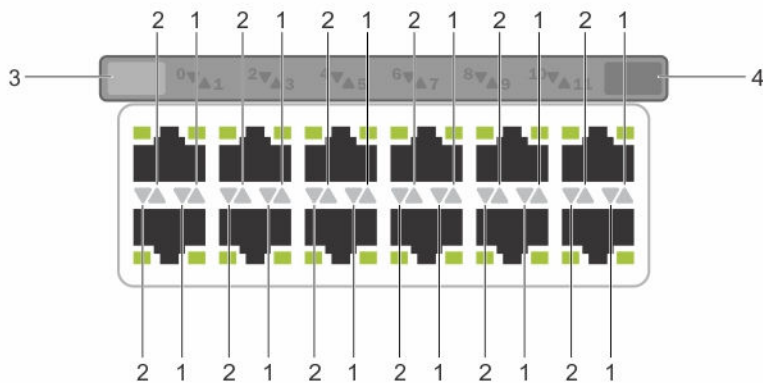

**Figure 7. Module LEDs**

- |                              |                           |
|------------------------------|---------------------------|
| 1. Port locator beacon LED   | 2. Port link/activity LED |
| 3. Module locator beacon LED | 4. Module status LED      |

 **NOTE:** The downward and upward pointing triangles denote the lower and upper port LEDs respectively.

**Table 3. Ethernet Port/Module LEDs**

| Label                   | LED Color/Display  | Description   |
|-------------------------|--|---|
| Port locator beacon LED | <ul style="list-style-type: none"> <li>Off</li> <li>Blue</li> </ul>        | <ul style="list-style-type: none"> <li>No activity</li> <li>Port beacon/locator</li> </ul>  |
| Port link/activity LED  | <ul style="list-style-type: none"> <li>Off</li> <li>Green solid</li> </ul> | <ul style="list-style-type: none"> <li>No link or interface disabled</li> <li>Link present and interface enabled (Ethernet module)</li> </ul> |

| Label                     | LED Color/Display  | Description  |
|---------------------------|--|--|
|                           | <ul style="list-style-type: none"> <li>Green blinking</li> </ul>                           | <ul style="list-style-type: none"> <li>Port has activity</li> </ul>  |
| Module locator beacon LED | <ul style="list-style-type: none"> <li>Off</li> <li>Blue</li> </ul>                        | <ul style="list-style-type: none"> <li>No activity</li> <li>Module beacon/locator</li> </ul>   |
| Module status LED         | <ul style="list-style-type: none"> <li>Off</li> <li>Green solid</li> <li>Yellow</li> </ul> | <ul style="list-style-type: none"> <li>Module is not powered up</li> <li>Module is powered up</li> <li>Problem detected with module</li> </ul> |

**Table 4. Copper Module LEDs**

| Label                               | LED Color/Display   | Description  |
|-------------------------------------|---|--|
| Port locator/Port link/activity LED | <ul style="list-style-type: none"> <li>Off</li> <li>Green solid</li> <li>Green blinking</li> <li>Amber</li> <li>Amber blinking</li> <li>Blue</li> </ul> | <ul style="list-style-type: none"> <li>No link or interface disabled</li> <li>10G link, interface enabled</li> <li>10G link activity</li> <li>1G/100M link, interface enabled</li> <li>1G/100M link activity</li> <li>Port beacon/locator</li> </ul> |

**Table 5. Unified Port/Module LEDs**

| Label                     | LED Color/Display  | Description  |
|---------------------------|--|--|
| Port locator beacon LED   | <ul style="list-style-type: none"> <li>Off</li> <li>Blue</li> <li>Green</li> </ul>                 | <ul style="list-style-type: none"> <li>No activity</li> <li>Port beacon/locator</li> <li>Fibre Channel mode enabled</li> </ul>                         |
| Port link/activity LED    | <ul style="list-style-type: none"> <li>Off</li> <li>Green solid</li> <li>Green blinking</li> </ul> | <ul style="list-style-type: none"> <li>No link or interface disabled</li> <li>Link present and interface enabled</li> <li>Port has activity</li> </ul> |
| Module locator beacon LED | <ul style="list-style-type: none"> <li>Off</li> <li>Green</li> </ul>                               | <ul style="list-style-type: none"> <li>No activity</li> <li>Module beacon/locator</li> </ul>   |
| Module status LED         | <ul style="list-style-type: none"> <li>Off</li> <li>Green solid</li> <li>Yellow</li> </ul>         | <ul style="list-style-type: none"> <li>Module is not powered up</li> <li>Module is powered up</li> <li>Problem detected with module</li> </ul>         |

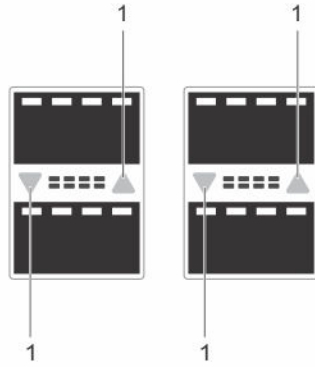

**Figure 8. QSFP+ Port LEDs**

1. Port link/activity LED

**Table 6. 40GbE Port/Module LEDs**

| Label                  | LED Color/Display  | Description  |
|------------------------|--|--|
| Port link/activity LED | <ul style="list-style-type: none"> <li>• Off</li> <li>• Green solid</li> <li>• Green blinking</li> </ul> | <ul style="list-style-type: none"> <li>• No link or interface disabled</li> <li>• Link present and interface enabled</li> <li>• Port has activity</li> </ul> |

**Table 7. 10G Base-T Port LEDs**

| Label                  | LED Color/Display  | Description  |
|------------------------|--|--|
| Port link/activity LED | <ul style="list-style-type: none"> <li>• Off</li> <li>• Green solid</li> <li>• Green blinking</li> </ul> | <ul style="list-style-type: none"> <li>• No link or interface disabled</li> <li>• Link present and interface enabled</li> <li>• Port has activity</li> </ul> |

# Installation

Before installing the switch, verify that you meet these guidelines:

- Enough clearance to the front of the switch so you can read the LEDs.
- AC/DC power cord reaches from the power outlet to the Utility-panel connector.
- Switch is rack-mounted before you install the power supply modules.
- Cabling is away from sources of electrical noise, such as radios, power lines, and fluorescent lighting. Make sure that the cabling is safely away from other devices that might damage the cables. If needed, allow one RU space between devices to provide room for cabling.
- Airflow around the switch and through the vents is unrestricted.
- Temperature around the unit does not exceed 104°F (40°C). If the switch is in a closed or multirack assembly, the temperature might be higher than normal room temperature.
- Humidity around the switch does not exceed 85 percent.
- Altitude at the installation site is below 6600 feet.
- Switch is installed in an environment as free as possible from dust and foreign conductive material (such as metal flakes from construction activities). Cooling mechanisms, such as fans and blowers in the switch, can draw dust and other particles causing contaminant buildup inside the chassis, which can result in system malfunction.

## Installing the Rack or Cabinet

**To install the S5000 system, Dell Networking recommends completing the installation procedures in the order presented here.**

- ▣ **NOTE:** Always handle the system and its components with care. Avoid dropping the S5000 chassis or its field replaceable units.
- ▣ **NOTE:** For proper ventilation, position the S5000 chassis in an equipment rack (or cabinet) with a minimum of 5 inches (12.7 cm) of clearance around exhaust vents. The acceptable ambient temperature ranges are listed in the *Environmental Parameters* section.
- △ **CAUTION:** Always wear an ESD-preventive wrist or heel ground strap when handling the S5000 and its components. As with all electrical devices of this type, take all necessary safety precautions to prevent injury when installing this system. ESD damage can occur if components are mishandled.

## Attaching the Mounting Brackets

The S5000 is shipped with mounting brackets (rack ears) and the required screws (eight screws) for rack or cabinet installation. The brackets are enclosed in a package with the chassis.

1. Take the brackets and screws out of their packaging.
2. Slide the mounting brackets, as shown in the following figure.

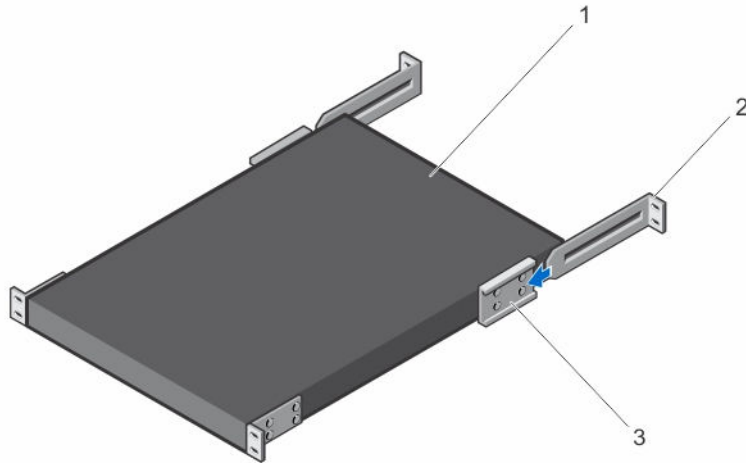

**Figure 9. Slide the mounting brackets**

- |  |                     |
|--|---------------------|
| 1. Utility side of the chassis         | 2. Mounting Bracket |
| 3. Holding Bracket (factory installed) |                     |

## Rack Mounting Safety Considerations

You may either place the switch on the rack shelf or mount the switch directly into a 19" wide, EIA-310-E- compliant rack.

- Rack loading — Overloading or uneven loading of racks may result in shelf or rack failure, which may damage equipment and cause possible personal injury. Stabilize racks in a permanent location before loading begins. Mount the components beginning at the bottom of the rack, then work to the top. Do not exceed your rack load rating.
- Power considerations — Connect only to the power source specified on the unit. When multiple electrical components are installed in a rack, ensure that the total component power ratings do not exceed the circuit capabilities. Overloaded power sources and extension cords present fire and shock hazards.
- Elevated ambient temperature — If installed in a closed rack assembly, the operating temperature of the rack environment may be greater than the room ambient temperature. Use care not to exceed the 40°C maximum ambient temperature of the switch.
- Reduced air flow — Install the equipment in the rack so that the amount of airflow required for safe operation of the equipment is not compromised.

- Reverse air flow — Necessary clearance is required to ensure cool air intake and to avoid hot air blow out from I/O panel.
- Reliable earthing — Maintain reliable earthing of rack-mounted equipment. Pay particular attention to the supply connections other than the direct connections to the branch circuit; for example, use of power strips.
- Do not mount the equipment with the Utility panel facing in the downward position.

**⚠ WARNING:** These instructions are a condensed reference. Read the safety instructions in your Safety, Environmental, and Regulatory information booklet before you begin.

**✎ NOTE:** The illustrations in this document are not intended to represent a specific switch.

## Installing the S5000 Chassis into a 4-Post Rack or Cabinet

**✎ NOTE:** Dell Networking recommends that one person hold the S5000 chassis in place while a second person attaches the brackets to the posts.

Attach the bracket "ears" to the rack or cabinet posts, using two screws for each bracket. Ensure the screws are tightened firmly.

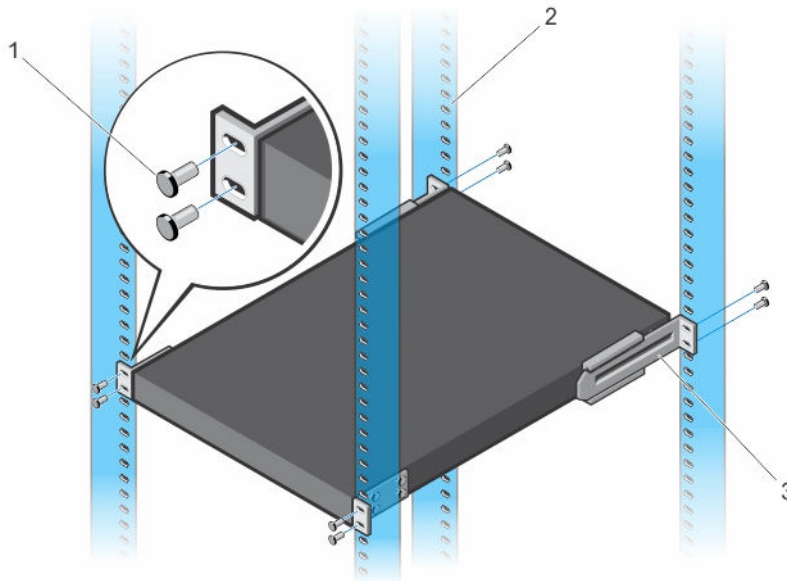

**Figure 10. Front Rack Installation**

1. Screws

2. 4-Post Rack or Cabinet

### 3. Mounting Bracket

## Rack Grounding

When you prepare your equipment rack, ensure that the rack is earth ground. You must ground the equipment rack to the same ground point the power service uses in your area. The ground path must be permanent.

## Important Points to Remember for Installing an Ethernet Module

- Installing and swapping of Ethernet modules must be done BEFORE power up. If you need to install or replace a module, power down the system before you install or replace it. If you install or replace a module when the system is powered up, the system does not recognize the module. Online insertion of modules can result in a catastrophic failure.



**WARNING: Electrostatic discharge (ESD) damage can occur if components are mishandled. Always wear an ESD-preventive wrist or heel ground strap when handling the S5000 and its components.**



**NOTE:** For the Ethernet module, the part name and port number are inscribed on the handle, as shown in the following figure:

- NOTE:** A blue color release latch indicates that the Ethernet module does not support hot swapping during switch operations. Instead, you must power down the switch before removing and replacing an Ethernet module. A red color release latch indicates that the Ethernet module supports hot swapping during switch operations.

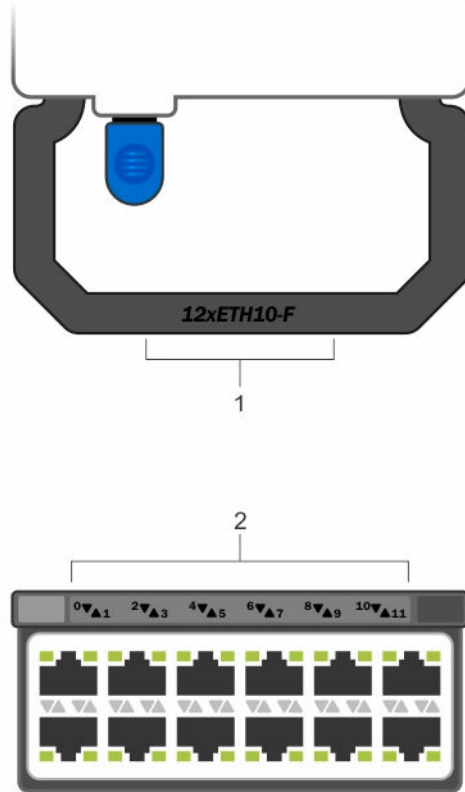

**Figure 11. Part name and Port number on the Ethernet Module Handle**

1 Part Name

2 Port Number

## Installing an Ethernet Module

1. Use the grab handle on the Ethernet module to slide it into the switch module slot.
2. Connect any network interface cables to the attached module.

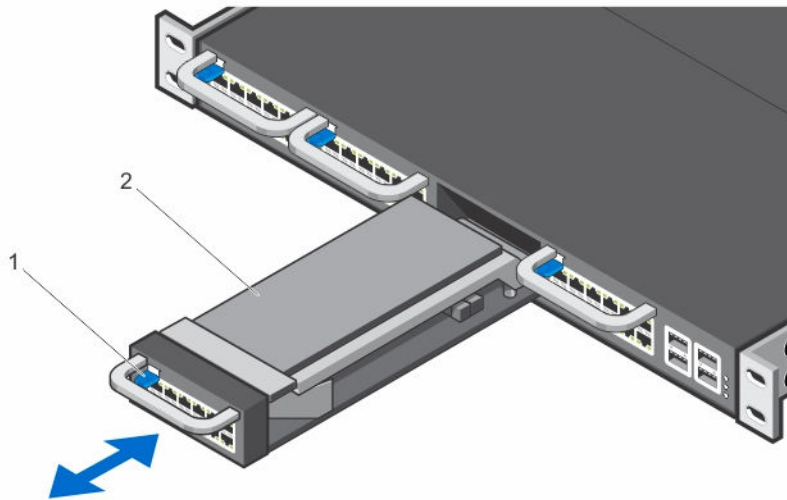

**Figure 12. Installing an Ethernet Module**

1. Release latch
2. Ethernet Module

## Important Points to Remember for Installing a Unified Port Module

- You must insert the Unified Port module only in slot 0.
- Installing and swapping of Unified Port modules must be done BEFORE power up. If you need to install or replace a module, power down the system before you install or replace it. If you install or replace a module when the system is powered up, the system does not recognize the module. Online insertion of modules can result in a catastrophic failure.
- The S5000 does not support the hot swapping of a Unified Port pluggable module during switch operations. Instead, you must power down the switch before removing and replacing a Unified Port module.

**⚠ WARNING: Electrostatic discharge (ESD) damage can occur if components are mishandled. Always wear an ESD-preventive wrist or heel ground strap when handling the S5000 and its components.**

 **NOTE:** The part name and port number of a Unified Port module are inscribed on the handle as shown below.

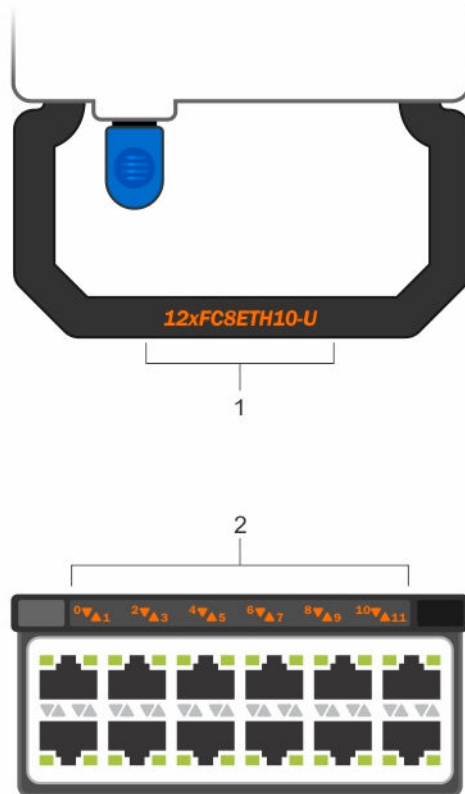

**Figure 13. Part name and Port number on the Unified Port Module Handle**

1 Part Name

2 Port Number

## Installing a Unified Port Module

1. Use the grab handle on the Unified Port module to slide it into the switch module slot.
2. Connect any network interface cables to the attached module.

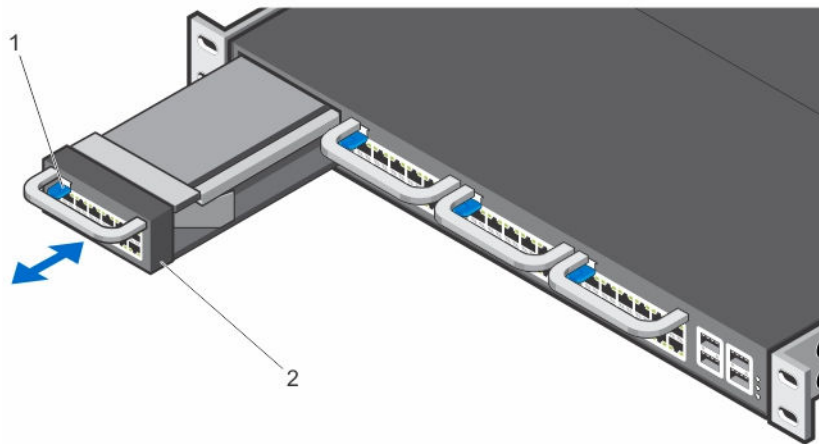

**Figure 14. Installing a Unified Port Module**

1. Release latch
2. Unified Port Module

## Important Points to Remember for Installing an AC Power Supply

- The PSU slides into the slot smoothly. Do not force a PSU into a slot as this action may damage the PSU or the S5000 chassis.
- The S5000 supports AC and DC power supplies with two air-flow directions (I/O to Utility and Utility to I/O). The S5000 does not support mixing PSU types, that is, you cannot replace an AC PSU with a DC PSU and an AC-R PSU with a DC-R PSU. The fan airflow direction for both the PSUs must be the same.
- For AC PSUs, an illuminated translucent handle indicates the power status.
- To view the log messages, use the `show logging` command. For more information, refer to the System Logs chapters of the *Dell Networking OS Command Line Reference Guide for the S5000 Switch* and *Dell Networking OS Configuration Guide for the S5000 Switch*.

**⚠ WARNING:** Although the switch can run on one PSU, Dell Networking OS highly recommends using two PSUs for full redundancy and proper cooling. If the switch needs to run with only one PSU for a time, be sure to cover the second PSU slot opening with a blank plate to avoid overheating.

**⚠ WARNING:** The Utility panel consists of four slots numbered from 0 to 3. Insert PSUs in slots 0 and 3.

**⚠ WARNING:** The PCB edge connector is at the bottom. Avoid installing the switch upside down.

**⚠ WARNING:** Electrostatic discharge (ESD) damage can occur if components are mishandled. Always wear an ESD-preventive wrist or heel ground strap when handling the S5000 and its components.

**CAUTION: DO NOT mix airflow directions. The airflow directions are color coded. A red label indicates that hot air is expelled from the PSU and a blue label indicates that hot air is expelled from the I/O. Both power supplies must use the same airflow direction (I/O to Utility or Utility to I/O). The power supplies and fans must have the same color strap. If you mismatch the airflows, the following error message appears and the system shuts down:**

```
00:02:19: %S5000:0 %CHMGR-2-PSU_TYPE_AIRFLOW_MISMATCH: Mismatching PSU airflow detected. Unit 0 shall get shutdown in next 60 seconds if mismatch not rectified. 00:02:19: %STKUNIT0-M:CP %CHMGR-1-PSU_AIRFLOW_COMBO_MISMATCH: Major alarm: Mismatching PSU airflow detected in unit 0
```

## Installing an AC Power Supply

1. Remove the PSU from the electro-static bag.
2. Use the grab handle to slide the PSU into the switch PSU slot (install the PSU-exposed PCB edge connector first). The PSU slot is keyed so that the PSU can be fully inserted in only one way. When you install the PSU correctly, it snaps into place and is flush with the back of the switch.

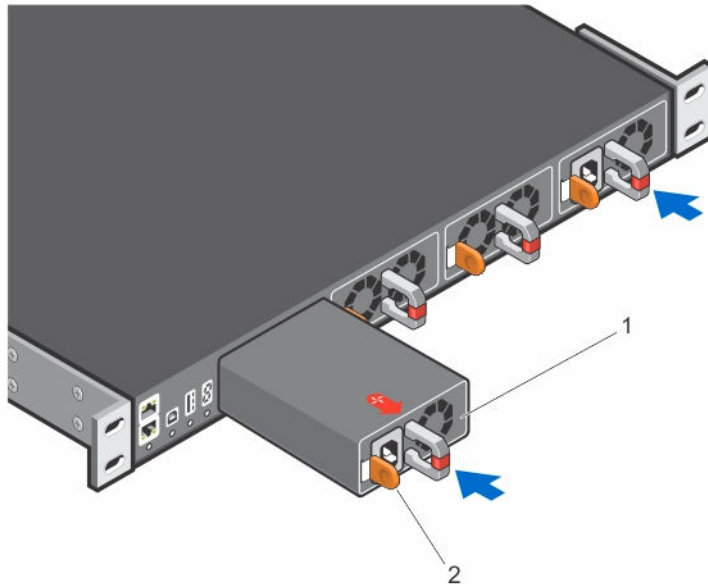

**Figure 15. Installing an AC Power Supply**

1. Slot 0 (for AC PSU 0)
2. Release latch
3. Plug in the AC3 prong cord from the switch PSU to the external power source (the AC wall outlet).

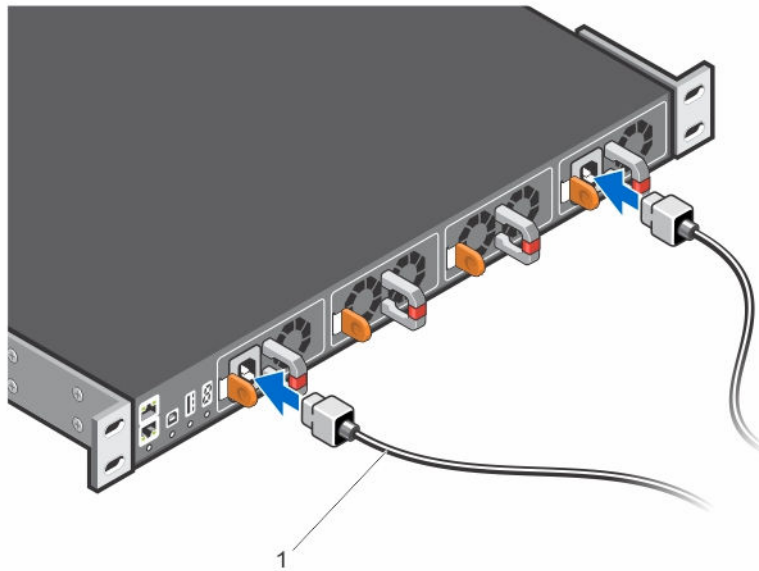

**Figure 16. Connecting AC Power Supply Cords**

1. AC3 Prong

**NOTE:** The system is powered-up as soon as you connect the power cord between the system and the power source.

**CAUTION:** Always disconnect the power cable before you service the power supply slots.

**CAUTION:** Use the power supply cord as the main disconnect device on the AC system. Ensure that the socket-outlet is located/installed near the equipment and is easily accessible.

4. Repeat steps 1 through 3 above using the second PSU.

**NOTE:** Ensure that the PSU is correctly installed. When you correctly install the PSU, the power connector is on the left side of the PSU.

## Assembling and Connecting the Safety Ground Wire for DC Power Supply

**WARNING:** For equipment using  $-(48-60)$  V DC power supplies, a qualified electrician must perform all connections to DC power and to safety grounds. Do not attempt connecting to DC power or installing grounds yourself. All electrical wiring must comply with applicable local or national codes and practices. Damage due to servicing that Dell Networking did not authorize is not covered by your warranty.

1. Strip the insulation from the end of the green/yellow wire, exposing approximately 4.5 mm (0.175 inch) of copper wire.
2. Using a hand-crimping tool (Tyco Electronics, 58433-3 or equivalent), crimp the ring-tongue terminal (Jeeson Terminals Inc., R5-4SA or equivalent) to the green/yellow wire (safety ground wire).
3. Connect the safety ground wire to the grounding post on the back of the system using a #6-32 nut equipped with a locking washer.

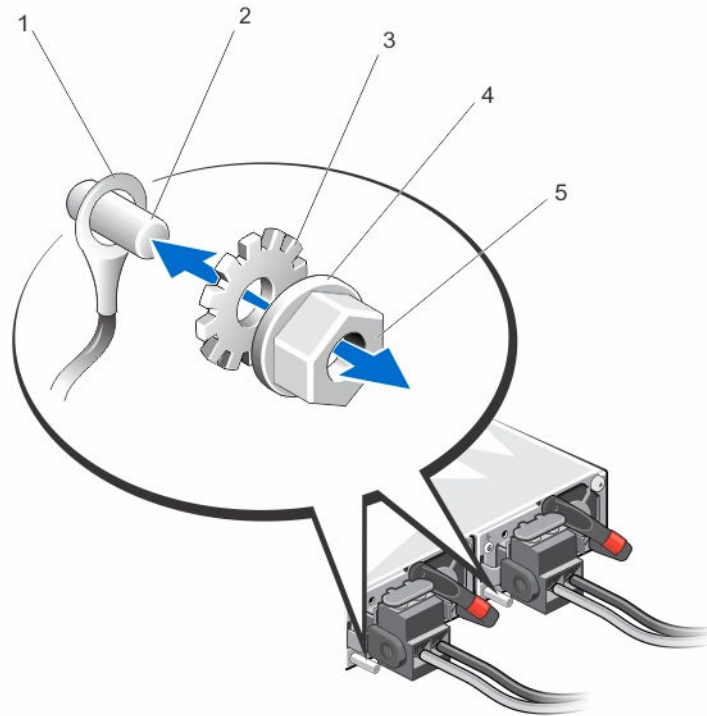



**Figure 17. Assembling and Connecting the Safety Ground Wire For DC Power Supply**

- |                       |                   |
|-----------------------|-------------------|
| 1. Safety ground wire | 2. Grounding post |
| 3. Locking washer     | 4. Spring washer  |
| 5. #6-32 nut          |                   |

## Important Points to Remember for Installing a DC Power Supply

- When using DC power supply, peel off the DC electrical label and place it on the main regulatory label found on the bottom of the S5000 chassis. Position this label over the AC electrical ratings within the dashed outline.
- The PSU slides into the slot smoothly. Do not force a PSU into a slot as this action may damage the PSU or the S5000 chassis.
- The S5000 supports AC and DC power supplies with two air-flow directions (I/O to Utility and Utility to I/O). The S5000 does not support mixing PSU types, that is, you cannot replace an AC PSU with a DC PSU and an AC-R PSU with a DC-R PSU. The fan airflow direction for both the PSUs must be the same.
- For DC PSUs, the power status LED is on the upper-left corner.
- A DC PSU must be properly grounded. The system does not work when plugged into the wrong power source polarity.
- To view the log messages, use the `show logging` command. For more information, refer to the System Logs chapters of the *Dell Networking OS Command Line Reference Guide for the S5000 Switch* and *Dell Networking OS Configuration Guide for the S5000 Switch*.

 **WARNING:** Although the switch can run on one PSU, Dell Networking highly recommends using two PSUs for full redundancy and proper cooling. If the switch needs to run with only one PSU for a time, be sure to cover the second PSU slot opening with a blank plate to avoid overheating.

 **WARNING:** The Utility panel consists of four slots numbered from 0 to 3. Insert PSUs in slots 0 and 3.

 **WARNING:** The PCB edge connector is at the bottom of the switch. Avoid installing the switch upside down.

 **WARNING:** Electrostatic discharge (ESD) damage can occur if components are mishandled. Always wear an ESD-preventive wrist or heel ground strap when handling the S5000 and its components.

 **CAUTION:** DO NOT mix airflow directions. The airflow directions are color coded. A red label indicates that hot air is expelled from the PSU and a blue label indicates that hot air is expelled from the I/O. Both fans must use the same airflow direction (I/O to Utility or Utility to I/O). The power supplies and fans must have the same color strap. If you mismatch the airflows, the following error message appears and the system shuts down:

```
00:02:19: %S5000:0 %CHMGR-2-PSU_TYPE_AIRFLOW_MISMATCH: Mismatching PSU
airflow detected. Unit 0 shall get shutdown in next 60 seconds if mismatch
not rectified. 00:02:19: %STKUNIT0-M:CP %CHMGR-1-
PSU_AIRFLOW_COMBO_MISMATCH: Major alarm: Mismatching PSU airflow detected
in unit 0
```

## Installing a DC Power Supply

1. Remove the PSU from the electro-static bag.
2. Use the grab handle to slide the PSU into the switch PSU slot (install the PSU-exposed PCB edge connector first). The PSU slot is keyed so that the PSU can be fully inserted in only one way. When you correctly install the PSU, it snaps into place and is flush with the back of the switch.

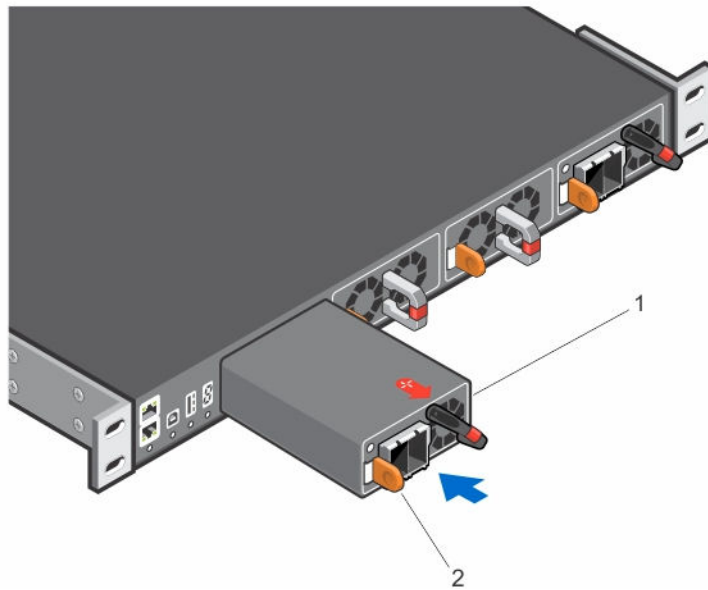

**Figure 18. Installing a DC Power Supply**

1. Slot 0 (for DC PSU 0)
2. Release latch
3. Strip the insulation from the ends of the DC power wires, exposing approximately 13 mm (0.5 inch) of copper wire.
  - ⚠ WARNING: Reversing polarity when connecting DC power wires can permanently damage the power supply or the system.**
4. Insert the copper ends into the mating connectors and tighten the captive screws at the top of the mating connector using a #2 Phillips screwdriver.
  - ⚠ WARNING: To protect the power supply from electrostatic discharge, you must cover the captive screws with the rubber cap before inserting the mating connector into the power supply.**
5. Rotate the rubber cap clockwise to fix it over the captive screws.
6. Insert the mating connector into the power supply.

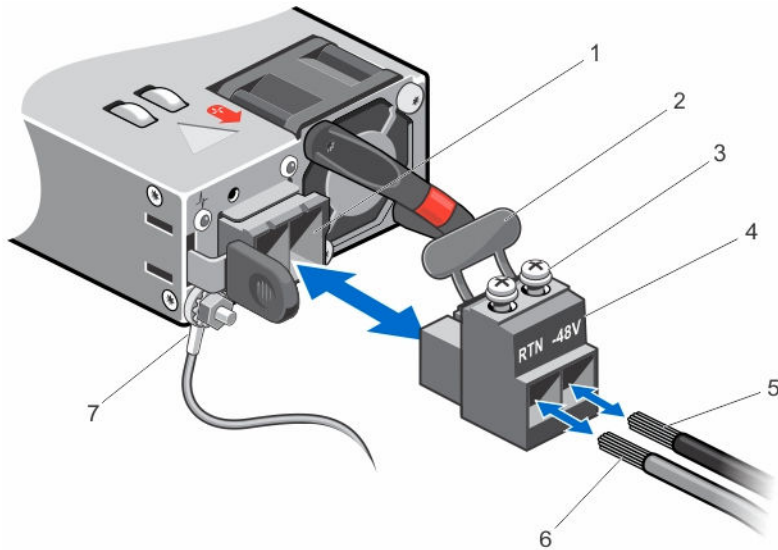

**Figure 19. Assembling the DC Input Power Wires**

- |                       |                       |
|-----------------------|-----------------------|
| 1. DC power socket    | 2. Rubber cap         |
| 3. Captive screws (2) | 4. DC power connector |
| 5. Wire (-48V)        | 6. Wire RTN           |
| 7. Grounding Wire     |                       |

**NOTE:** The system is powered-up as soon as the power cord is connected between the system and the power source.

**CAUTION:** Always disconnect the power cable before you service the power supply slots.

**CAUTION:** Use the power supply cord as the main disconnect device on the AC or DC system. Ensure that the socket-outlet is located/installed near the equipment and is easily accessible.

7. Repeat steps 1 through 6 using the second PSU.

**NOTE:** Ensure that the PSU is correctly installed. When you correctly install the PSU, the power connector is on the left side of the PSU.

## Installing the Ferrite Bead for DC Power and Return Cables

Add a ferrite bead to the DC power and return cables of the master module. Install the bead with a single loop.

1. Open ferrite bead with the depressions facing up.
2. Wrap the DC power and return cables around the ferrite bead twice if two turns of the cable fit inside the ferrite, otherwise simply clamp the ferrite onto both cables.

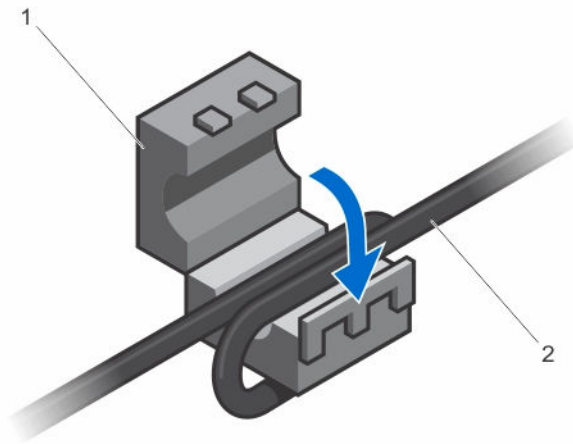
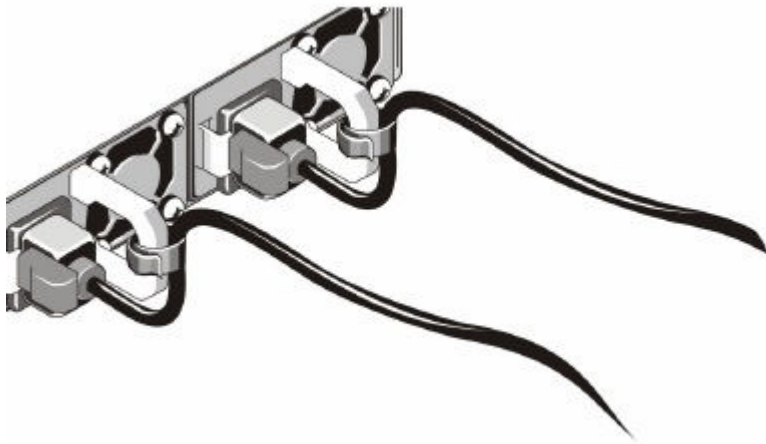

**Figure 20. Installing the Ferrite Bead for DC Power and Return Cables**

1. Ferrite Bead
2. DC Power and Return Cables
3. Leave approximately 4 to 5 inches of the DC power and return cables end protruding from the ferrite.
4. Snap the ferrite bead shut.

## Securing Power Cables

1. Bend the system power cables, as shown in the following illustration, and attach to the cable clasp.



**Figure 21. Securing Power Cables**

2. Plug the other end of the power cables into a grounded electrical outlet or a separate power source such as an uninterruptible power supply (UPS) or a power distribution unit (PDU).

 **NOTE:** For better performance, ensure that the system is connected to a stand-alone power source with stable power supply.

## Important Points to Remember for Installing a Fan Module

- The Utility panel consists of four slots numbered from 0 to 3. Insert the fan modules in slots 1 and 2.
- If a fan module fails, the system continues to operate without a significant degradation in cooling capacity for a six-hour duration.
- The cooling system is designed such that, during normal operation, the fans typically run at somewhere between 50 and 75 percent of their maximum speed at 26°C ambient temperature. This feature results in lower noise and higher average fan life. The switch increases the fan speed to maximum if the facility air condition fails or if a fan fails.
- The fan speed increases and decreases automatically based on the internal temperature. The switch never intentionally turns off the fans.
- For proper ventilation, position the S5000 in an equipment rack (or cabinet) with a minimum of 5 inches (12.7 cm) of clearance around the exhaust vents. When you install two S5000 systems near each other, position the two chassis at least 5 inches (12.7 cm) apart to permit proper airflow. The acceptable ambient temperature ranges are listed in [Technical Specifications](#).
- To view the log messages, use the `show logging` command. For more information, refer to the System Logs chapters of the *Dell Networking OS Command Line Reference Guide for the S5000 Switch* and *Dell Networking OS Configuration Guide for the S5000 Switch*.

 **CAUTION: DO NOT mix airflow directions. The airflow directions are color coded. A red label indicates that hot air is expelled from the PSU and a blue label indicates that hot air is expelled from the I/O. Both fans must use the same airflow direction (I/O to Utility or Utility to I/O). The power supplies and fans must have the same color strap. If you mismatch the airflows, the following error message appears and the system shuts down:**

```
00:00:53: %S5000:3 %CHMGR-2-PSU_TYPE_AIRFLOW_MISMATCH: Mismatching PSU and
FAN airflow detected. Unit 0 shall get shutdown in next 60 seconds if
mismatch not rectified.
00:00:53: %STKUNIT3-M:CP %CHMGR-1-PSU_AIRFLOW_COMBO_MISMATCH: Major alarm:
Mismatching PSU and FAN airflow detected in unit 0
```

The fan modules are field replaceable. Module slot 1 is on the left side of the chassis; module slot 2 is on the right side of the chassis.

## Installing a Fan Module

1. Take the fan module out of the shipping box.
2. Use the grab handle to slide the fan module into the switch fan slot, as shown below.

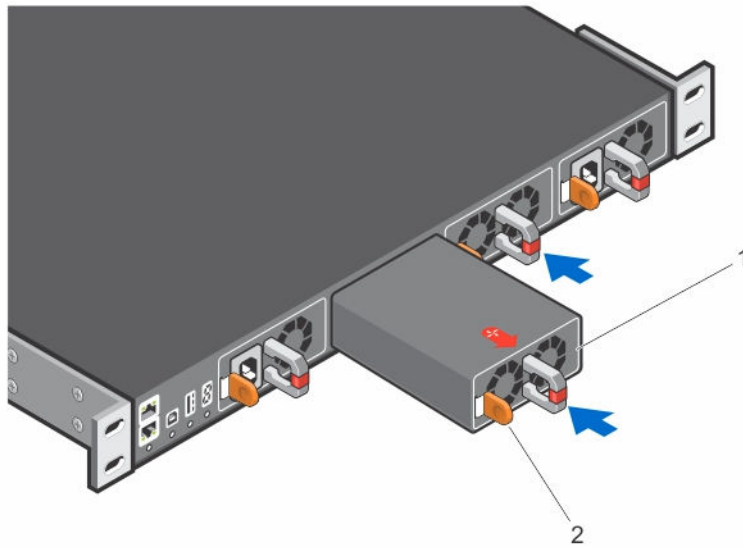

**Figure 22. Installing a Fan Module**

1. Fan module 0/Slot 1
2. Release latch

## Installing the SFP+ and QSFP+ Optics

The S5000 has 48 small form-factor pluggable plus (SFP+) optical ports and four QSFP+ optical ports. For a list of supported optics, refer to the S5000 data sheet: <http://www.dell.com/us/enterprise/p/force10-s-series/pd>.

**CAUTION:** ESD damage can occur if the components are mishandled. Always wear an ESD-preventive wrist or heel ground strap when handling the S5000 and its components.

**WARNING:** When working with optical fibres, follow all the warning labels and always wear eye protection. Never look directly into the end of a terminated or unterminated fibre or connector as it may cause eye damage.

1. Position the optic so it is in the correct position. The optic has a key that prevents it from being inserted incorrectly.
2. Insert the optic into the port until it gently snaps into place.

**NOTE:** Both rows of QSFP+ ports require that you install the 40GbE optics with the tabs facing up.

**NOTE:** When you cable the ports, be sure not to interfere with the airflow from the small vent holes above and below the ports.

## Splitting QSFP+ Ports to SFP+ Ports

The S5000 supports splitting a single 40GbE QSFP+ port into four 10GbE SFP+ ports using one of the supported breakout cables.

For a list of supported optics, refer to the S5000 data sheet: <http://www.dell.com/us/enterprise/p/force10-s-series/pd>.

- Configure the system to recognize the port mode change.  
CONFIGURATION mode

```
stack-unit unit-number port number portmode quad
```

- *stack-unit*<*unit-number*> - Enter the stack member unit identifier of the stack member to reset. The range is 0 to 11. The default is 0.
- *port* <*number*>- Enter the port number of the 40GbE port to be split. The range is 48 to 60.
- *portmode quad* - Configure a 40GbE port to operate in 4x10GbE mode.

### Example of splitting a QSFP+ port to SFP+ ports

```
stack-unit 0 port 52 portmode quad
```

### Important Points to Remember

- You cannot use split ports as a stack-link to stack an S5000 unit.
- The quad port must be in a default configuration before you can split it into four 10GbE SFP+ ports. When you split the port, the 40GbE port is lost in the running configuration. Be sure that the port is also removed from other L2/L3 feature configurations.
- For the split-port change to take effect, you must reload the system after issuing the CLI change commands.

## Supplying Power and Powering Up the System

Supply power to the S5000 system after the chassis is mounted in a rack or cabinet.

 **WARNING: Installing and swapping of Unified Port or Ethernet modules must be done BEFORE power up. If you need to replace a module, power down the system before you replace it. If you replace a module when the system is powered up, the system does not recognize the module. Online insertion of modules can result in a catastrophic failure.**

Dell Networking recommends reinspecting your system prior to powering up. Verify that:

- The equipment is properly secured to the rack.
- The equipment rack is properly mounted and grounded.
- The ambient temperature around the unit (which may be higher than the room temperature) is within the limits specified for the S5000.
- There is sufficient airflow around the chassis.
- The input circuits are correctly sized for the loads and that you use sufficient overcurrent protection devices.

 **NOTE:** For powering up an AC PSU, an AC power cable is included in the shipping container. You must order all other power cables separately.

 **CAUTION:** ESD damage can occur if the components are mishandled. Always wear an ESD-preventive wrist or heel ground strap when handling the S5000 and its components.

When the system powers up, the fans come on at high speed. The fan speed slows as the system boots up. The power status LED blinks until the boot-up sequence is complete. When the boot up is complete, the power status LED is steadily lit.

## AC Power

 **CAUTION:** Ensure that the PSU is installed correctly. The AC power connector must be on the left side of the PSU and the status LED at the top of the PSU.

Connect the plug to each AC power connector. Make sure that the power cord is secure.

As soon as the cable is connected between the S5000 and the power source, the chassis is powered-up; there is no on/off switch.

## DC Power

Connect the plug to each DC receptacle. Make sure that the power cord is secure and the polarity is correct.

As soon as the cable is connected between the S5000 and the power source, the chassis is powered-up; there is no on/off switch.

# Performing the Initial Configuration

The S5000 has two management ports available for system access — a console port and a universal serial bus (USB)-B port. The USB-B port acts the same as the console port. The terminal settings are the same for both access ports.

The S5000 supports bare metal provisioning (BMP). For information about how to configure BMP, refer to *FTOS Configuration Guide for the S5000 Switch*.

## Software Configuration Overview

To configure the S5000, follow these steps:

1. Access the RJ-45/RS-232 console port.
2. Enter the initial configuration information.
3. Configure the enable password.
4. Configure a host name.
5. Configure layer 2 (data Link) mode.
6. Configure the management port IP address.
7. Configure a management route.
8. Configure a username and password.
9. Create a port-based VLAN.
10. Assign interfaces to a VLAN.
11. Assign an IP address to a VLAN.
12. Connect the S5000 to the network.

## Accessing the RJ-45/RS-232 Console Port

 **NOTE:** Before starting this procedure, be sure that you have a terminal emulation program already installed on your PC.

The DB9 RS-232/RJ-45 console port is labeled on the lower left-hand side of the S5000 as you face the Utility side of the chassis.

1. Install an RJ-45 copper cable into the console port. Use a rollover cable to connect the S5000 console port to a terminal server.
2. Connect the other end of the cable to the DTE terminal server.
3. Set the default terminal settings as follows:
  - a. 9600 baud rate
  - b. No parity

- c. 8 data bits
- d. 1 stop bit
- e. No flow control



Figure 23. RS-232/RJ-45 Console Port

## Accessing the RJ-45 Console Port with a DB-9 Adapter

You can connect to the console using an RJ-45 to RJ-45 rollover cable and an RJ-45 to DB-9 female DTE adapter to a terminal server (for example, a PC).

The pin assignments between the console and a DTE terminal server are as follows:

Table 8. Pin Assignments Between the Console and a DTE Terminal Server

| S5000 Console Port | RJ-45 to RJ-45 Rollover Cable | RJ-45 to RJ-45 Rollover Cable | RJ-45 to DB-9 Adapter | Terminal Server Device |
|--------------------|-------------------------------|-------------------------------|-----------------------|------------------------|
| Signal             | RJ-45 Pinout                  | RJ-45 Pinout                  | DB-9 Pin              | Signal                 |
| RTS                | 1                             | 8                             | 8                     | CTS                    |
| NC                 | 2                             | 7                             | 6                     | DSR                    |
| TxD                | 3                             | 6                             | 2                     | RxD                    |
| GND                | 4                             | 5                             | 5                     | GND                    |
| GND                | 5                             | 4                             | 5                     | GND                    |
| RxD                | 6                             | 3                             | 3                     | TxD                    |
| NC                 | 7                             | 2                             | 4                     | DTR                    |
| CTS                | 8                             | 1                             | 7                     | RTS                    |

## Accessing the USB-B Console Port

The terminal settings are the same for the USB-B port and the console port:

- 9600 baud rate
- No parity

- 8 data bits
- 1 stop bit
- No flow control

When you connect the USB-B port, it becomes the primary connection and, when the system is connected, it sends all messages to the USB-B drive.

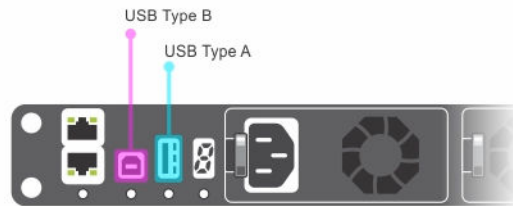

**Figure 24. USB-B Console Port Connector**

1. Power on the PC.
2. Install the necessary USB device drivers (you will need an Internet connection). For assistance, contact Dell Networking Technical Support.
3. Connect the USB-A end of cable into an available USB port on the PC.
4. Connect the USB-B end of cable into the USB-B console port on the S5000.
5. Power on the S5000.
6. Open your terminal software emulation program to access the S5000.
7. Set the terminal connection settings. Use these settings.
  - 9600 baud rate
  - No parity
  - 8 data bits
  - 1 stop bit
  - No flow control

The CLI prompt appears (`FTOS>_`) when you are connected to the S5000.

**NOTE:** Only one of the console ports can be active at a time; the USB console takes priority over the RJ-45 console by default. When a USB Host (PC) is plugged into the USB console port, the hardware automatically switches over to use the USB console. When you remove the USB cable or the PC deactivates the USB connection, the hardware automatically switches to the RJ-45 console interface.

## Enter the Initial Configuration Information

To set up the switch, assign an IP address and other configuration information necessary for the switch to communicate with the local routers and the Internet. The minimal configuration provided here does not cover most of the features; it simply allows you to perform other configuration tasks using a Telnet connection from your management network. To configure other features and interfaces, refer to the *FTOS Configuration Guide for the S5000 Switch*.

## IP Settings

You will need the following information from your network administrator:

- Switch IP address
- Subnet mask (IP netmask)
- Default gateway (router)
- Enable secret password
- Enable password
- Telnet password

## Configuring the Enable Password

To access EXEC Privilege mode, use the `enable` command. EXEC Privilege mode is unrestricted by default. Configure a password as a basic security measure.

There are two types of enable passwords:

- `enable password` — stores the password in the running/startup configuration using a data encryption standard (DES) encryption method.
- `enable secret` — is stored in the running/startup configuration in a stronger, MD5 encryption method.

 **NOTE:** Dell Networking recommends using the `enable secret` password.

- Create a password to access EXEC Privilege mode.

CONFIGURATION MODE

```
enable [password | secret] [level level] [encryption-type]
```

*level* is the privilege level and is not required. The default is **15**.

*encryption-type*: specifies how you are inputting the password and is not required. The default is **0**.

- 0 is for inputting the password in clear text.
- 7 is for inputting a password that is already encrypted using a DES hash. Obtain the encrypted password from the configuration file of another Dell Networking system.
- 5 is for inputting a password that is already encrypted using an MD5 hash. Obtain the encrypted password from the configuration file of another Dell Networking system.

## Configuring a Host Name

The host name appears in the prompt. The default host name is `FTOS`. Host names must start with a letter, end with a letter or digit, and must have characters, letters, digits, and hyphens in the string.

- Create a host name.  
CONFIGURATION mode

```
hostname name
```

## Navigate CLI modes

The FTOS prompt changes to indicate the CLI mode. You must move linearly through the command modes, except for the `end` command which takes you directly to EXEC Privilege mode and the `exit` command which moves you up one command mode level.

## Default Configuration

A version of FTOS is preloaded onto the S5000; however, the system is not configured when you power up for the first time (except for the default host name, which is `FTOS`). You must configure the system using the CLI.

## Configuring Layer 2 (Data Link) Mode

To enable Layer 2 data transmissions through an individual interface, use the `switchport` command in INTERFACE mode. You cannot configure switching or Layer 2 protocols, such as spanning tree protocol (STP), on an interface unless the interface has been set to Layer 2 mode.

1. Enable the interface.  
INTERFACE mode  
  
`no shutdown`
2. Place the interface in Layer 2 (switching) mode  
INTERFACE mode  
  
`switchport`

To view the interfaces in Layer 2 mode, use the `show interfaces switchport` command in EXEC mode.

## Accessing the System Remotely

You can configure the system to access it remotely by Telnet.

The system has a dedicated management port and a management routing table that is separate from the IP routing table.

1. Configure an IP address for the management port (refer to [Configuring the Management Port IP Address](#)).
2. Configure a management route with a default gateway (refer to [Configuring a Management Route](#)).
3. Configure a username and password (refer to [Configuring a Username and Password](#)).

## Configuring the Management Port IP Address

To access the system remotely, assign IP addresses to the management ports.

 **NOTE:** Assign different IP addresses to each stack-unit's management port.

1. Enter INTERFACE mode for the Management port.  
CONFIGURATION mode

```
interface ManagementEthernet slot/port
```

- *slot* range: 0
- *port* range: 0

2. Assign an IP address to the interface.  
INTERFACE mode

```
ip address ip-address/mask
```

- *ip-address*: an address in dotted-decimal format (A.B.C.D).
- *mask*: a subnet mask in /prefix-length format (/ xx).

3. Enable the interface.  
INTERFACE mode

```
no shutdown
```

## Configuring a Management Route

Define a path from the system to the network from which you are accessing the system remotely. Management routes are separate from IP routes and are only used to manage the system through the management port.

- Configure a management route to the network from which you are accessing the system.  
CONFIGURATION mode

```
management route ip-address/mask gateway
```

- *ip-address*: the network address in dotted-decimal format (A.B.C.D).
- *mask*: a subnet mask in /prefix-length format (/ xx).
- *gateway*: the next hop for network traffic originating from the management port.

## Configuring a Username and Password

- Configure a username and password to access the system remotely.  
CONFIGURATION mode

```
username username password [encryption-type]
```

*encryption-type* specifies how you are inputting the password, is 0 by default, and is not required.

- 0 is for inputting the password in clear text.
- 7 is for inputting a password that is already encrypted using a Type 7 hash. Obtaining the encrypted password from the configuration of another Dell Networking system.

## Creating a Port-based VLAN

The default virtual local area network (VLAN) (VLAN 1) is part of the system startup configuration and does not require configuration.

To configure a port-based VLAN, create the VLAN and then add physical interfaces or port channel (LAG) interfaces to the VLAN.

- Configure a port-based VLAN (if the VLAN-ID is different from the Default VLAN ID) and enter INTERFACE VLAN mode.  
CONFIGURATION mode

```
interface vlan vlan-id
```

After you create a VLAN, you must assign interfaces in Layer 2 mode to the VLAN to activate the VLAN.

To view the configured VLANs, use the `show vlan` command in EXEC Privilege mode.

## Assigning Interfaces to a VLAN

You can only assign interfaces in Layer 2 mode to a VLAN using the `tagged` and `untagged` commands. To place an interface in Layer 2 mode, use the `switchport` command.

You can designate Layer 2 interfaces as tagged or untagged. When you place an interface in Layer 2 mode using the `switchport` command, the interface is automatically designated untagged and placed in the Default VLAN.

To view which interfaces are tagged or untagged and to view which VLAN the interfaces belong, use the `show vlan` command.

To view just the interfaces that are in Layer 2 mode, use the `show interfaces switchport` command in EXEC Privilege mode or EXEC mode.

To tag frames leaving an interface in Layer 2 mode, you must assign that interface to a port-based VLAN to tag it with that VLAN ID.

1. Access the INTERFACE VLAN mode of the VLAN to which you want to assign the interface.  
CONFIGURATION mode

```
interface vlan vlan-id
```

2. Enable an interface to include the IEEE 802.1Q tag header.  
INTERFACE mode

```
tagged interface
```

To move untagged interfaces from the Default VLAN to another VLAN, use the `untagged` command.

3. Access the INTERFACE VLAN mode of the VLAN to which you want to assign the interface.  
CONFIGURATION mode

```
interface vlan vlan-id
```

4. Configure an interface as untagged. This command is available only in VLAN interfaces.  
INTERFACE mode

```
untagged interface
```

## Assigning an IP Address to a VLAN

VLANs are a Layer 2 feature. For two physical interfaces on different VLANs to communicate, you must assign an IP address to the VLANs to route traffic between the two interfaces. The `shutdown` command in INTERFACE mode does not affect Layer 2 traffic on the interface.

**NOTE:** You cannot assign an IP address to the Default VLAN, which, by default, is VLAN 1. To assign another VLAN ID to the Default VLAN, use the default `vlan-id vlan-id` command.

- Configure an IP address and mask on the interface.

INTERFACE mode

```
ip address ip-address mask [secondary]
```

## Connecting the S5000 to the Network

After you have completed the hardware installation and software configuration for the S5000 system, you can connect to your company network by following your company's cabling requirements.



Figure 25. RJ-45 Network/Management Port

## Technical Specifications

 **NOTE:** Operate the product at an ambient temperature not higher than 40°C.

 **CAUTION: Lithium Battery Caution: There is a danger of explosion if the battery is incorrectly replaced.**

 **NOTE:** Replace the battery only with same or equivalent type. Dispose of the batteries according to the manufacturer's instructions.

**Table 9. Chassis Physical Design**

| Parameter  | Specifications  |
|--|---|
| Height   | 1.71 inches (43.5 mm)   |
| Width  | 17.4 inches (441 mm)  |
| Depth  | 28 inches (711 mm)  |
| Chassis weight with factory-installed components | 34 pounds (approx.) (15.42 kg)  |
| Rack clearance required                          | <ul style="list-style-type: none"> <li>• Front: 5 inches (12.7 cm)</li> <li>• Rear: 5 inches (12.7 cm)</li> </ul> |

**Table 10. Environmental Parameters**

| Parameter              | Specifications                        |
|------------------------|---------------------------------------|
| Operating temperature  | 32° to 104°F (0° to 40°C)             |
| Operating humidity     | 10 to 85 percent (RH), noncondensing  |
| Storage temperature    | -40° to 158°F (-40° to 70°C)          |
| Storage humidity       | 5 to 95 percent (RH), noncondensing   |
| Relative humidity      | 10 to 85 percent, noncondensing       |
| Maximum thermal output | 2388 BTU/hr                           |
| Maximum Altitude       | No performance degradation to 6600 ft |

**Table 11. Power Requirements**

| Parameter                       | Specifications                   |
|---------------------------------|----------------------------------|
| AC Power supply                 | 100 VAC ~ 240 VAC 50/60 Hz       |
| DC Power supply                 | -48V ~ -60V VDC                  |
| Maximum current draw per system | 7 A @ 100 VAC<br>3.5 A @ 200 VAC |
| Maximum power consumption       | 700 Watts                        |

